

9519

Coltelli sagomati di ricambio in HM integrale.

Profiled spare knives HM integral.

Couteaux profilés de rechange en HM intégral.

Messern mit Profil zu HM integral.

Cuchillas perfiladas utilizadas como repuestos en HM macizo.

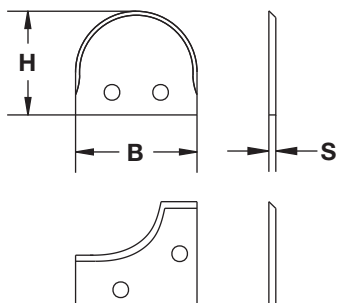

Dimensioni	ID nr.					
	BxHxS	n°6 pz	n°12 pz	n°24 pz	n°36 pz	n°60 pz
20x20x2	9519001	9519001/A	9519001/B	9519001/C	9519001/D	9519001/E
20x25x2	9519002	9519002/A	9519002/B	9519002/C	9519002/D	9519002/E
20x30x2	9519003	9519003/A	9519003/B	9519003/C	9519003/D	9519003/E
20x35x2	9519004	9519004/A	9519004/B	9519004/C	9519004/D	9519004/E
25x20x2	9519005	9519005/A	9519005/B	9519005/C	9519005/D	9519005/E
25x25x2	9519006	9519006/A	9519006/B	9519006/C	9519006/D	9519006/E
25x30x2	9519007	9519007/A	9519007/B	9519007/C	9519007/D	9519007/E
25x35x2	9519008	9519008/A	9519008/B	9519008/C	9519008/D	9519008/E
30x20x2	9519009	9519009/A	9519009/B	9519009/C	9519009/D	9519009/E
30x25x2	9519010	9519010/A	9519010/B	9519010/C	9519010/D	9519010/E
30x30x2*	9519011	9519011/A	9519011/B	9519011/C	9519011/D	9519011/E
30x35x2	9519012	9519012/A	9519012/B	9519012/C	9519012/D	9519012/E
30x40x2	9519013	9519013/A	9519013/B	9519013/C	9519013/D	9519013/E
35x25x2	9519014	9519014/A	9519014/B	9519014/C	9519014/D	9519014/E
35x30x2*	9519015	9519015/A	9519015/B	9519015/C	9519015/D	9519015/E
35x35x2*	9519016	9519016/A	9519016/B	9519016/C	9519016/D	9519016/E
35x40x2	9519017	9519017/A	9519017/B	9519017/C	9519017/D	9519017/E
40x20x2	9519018	9519018/A	9519018/B	9519018/C	9519018/D	9519018/E
40x25x2	9519019	9519019/A	9519019/B	9519019/C	9519019/D	9519019/E
40x30x2*	9519020	9519020/A	9519020/B	9519020/C	9519020/D	9519020/E
40x35x2*	9519021	9519021/A	9519021/B	9519021/C	9519021/D	9519021/E
40x40x2*	9519022	9519022/A	9519022/B	9519022/C	9519022/D	9519022/E
50x25x2	9519023	9519023/A	9519023/B	9519023/C	9519023/D	9519023/E
50x30x2	9519024	9519024/A	9519024/B	9519024/C	9519024/D	9519024/E
50x35x2	9519025	9519025/A	9519025/B	9519025/C	9519025/D	9519025/E
50x40x2	9519026	9519026/A	9519026/B	9519026/C	9519026/D	9519026/E
50x45x2	9519027	9519027/A	9519027/B	9519027/C	9519027/D	9519027/E
60x30x2	9519028	9519028/A	9519028/B	9519028/C	9519028/D	9519028/E
60x35x2	9519029	9519029/A	9519029/B	9519029/C	9519029/D	9519029/E
60x40x2	9519030	9519030/A	9519030/B	9519030/C	9519030/D	9519030/E
80x30x2	9519031	9519031/A	9519031/B	9519031/C	9519031/D	9519031/E
80x35x2	9519032	9519032/A	9519032/B	9519032/C	9519032/D	9519032/E
80x40x2	9519033	9519033/A	9519033/B	9519033/C	9519033/D	9519033/E
100x30x2	9519034	9519034/A	9519034/B	9519034/C	9519034/D	9519034/E
100x35x2	9519035	9519035/A	9519035/B	9519035/C	9519035/D	9519035/E
100x40x2	9519036	9519036/A	9519036/B	9519036/C	9519036/D	9519036/E

*Disponibile anche con fori sfalsati

*Also available with staggered holes

Coltelli da sagomare di ricambio in HM integrale.

Spare knives to profile HM integral.

Couteaux à profiler de rechange en HM intégral.

Messern zu profilieren zu HM integral.

Cuchillas por perfilar utilizadas como repuestos en HM macizo.

B	ID nr.
BxHxS	n°1 pz
20x20x2	9519 101
20x25x2	9519 102
20x30x2	9519 103
20x35x2	9519 104
25x20x2	9519 105
25x25x2	9519 106
25x30x2	9519 107
25x35x2	9519 108
30x20x2	9519 109
30x25x2	9519 110
30x30x2*	9519 111
30x35x2	9519 112
30x40x2	9519 113
35x25x2	9519 114
35x30x2*	9519 115
35x35x2*	9519 116
35x40x2	9519 117
40x20x2	9519 118
40x25x2	9519 119
40x30x2*	9519 120
40x35x2*	9519 121
40x40x2*	9519 122
50x25x2	9519 123
50x30x2	9519 124
50x35x2	9519 125
50x40x2	9519 126
50x45x2	9519 127
60x30x2	9519 128
60x35x2	9519 129
60x40x2	9519 130
80x30x2	9519 131
80x35x2	9519 132
80x40x2	9519 133

*Disponibile anche con fori sfalsati

*Also available with staggered holes

9519a

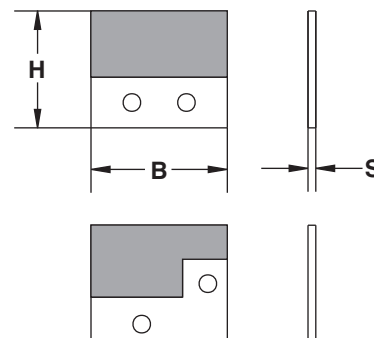

9519b

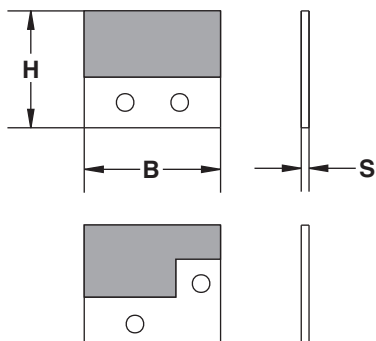

Controcoltelli da sagomare di ricambio in HM integrale.

Spare back-knives to profile HM integral.

Derrière-couteaux à profiler de rechange en HM intégral.

Gegen-Messern zu profilieren zu HM integral.

Contracuchillas por perfilar utilizadas como repuestos en HM macizo.

Dimensioni	ID nr.
BxHxS	n°1 pz
30x28x5	9519 201
30x33x5	9519 202
30x38x5	9519 203
35x28x5	9519 213
35x33x5	9519 214
35x38x5	9519 215
40x28x5	9519 204
40x33x5	9519 205
40x38x5	9519 206
60x28x5	9519 207
60x33x5	9519 208
60x38x5	9519 209
80x28x5	9519 210
80x33x5	9519 211
80x38x5	9519 212

■ = AREA SAGOMABILE / AREA THAT CAN BE SHAPED

9519c

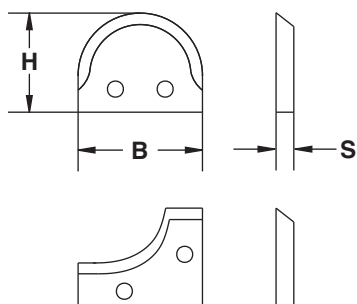

Controcoltelli sagomati di ricambio in HM integrale.

Profiled spare back-knives HM integral.

Derrière-couteaux profilés de rechange en HM intégral.

Gegen-Messern mit profil zu HM integral.

Contracuchillas perfiladas utilizadas como repuestos en HM macizo.

Dimensioni	ID nr.
BxHxS	n°1 pz
30x28x5	9519 301
30x33x5	9519 302
30x38x5	9519 303
35x28x5	9519 313
35x33x5	9519 314
35x38x5	9519 315
40x28x5	9519 304
40x33x5	9519 305
40x38x5	9519 306
60x28x5	9519 307
60x33x5	9519 308
60x38x5	9519 309
80x28x5	9519 310
80x33x5	9519 311
80x38x5	9519 312

Coltelli sagomati di ricambio per art. 2007.
Shaped spare cutters for art. 2007.
 Couteaux de rechange à profil pour art. 2007.
Messern mit Profil für art. 2007.
 Cuchillas perfiladas utilizadas como repuestos del art. 2007.

COLTELLI SAGOMATI			
Dimensioni BxHxS	R7,5-10 30x40x2	R5-15 30x40x2	R20 30x40x2
ID nr.	9520 001	9520 002	9520 003

9520

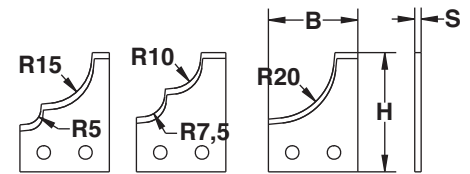

Coltelli sagomati di ricambio per art. 2008.
Shaped spare cutters for art. 2008.
 Couteaux de rechange à profil pour art. 2008.
Messern mit Profil für art. 2008.
 Cuchillas perfiladas utilizadas como repuestos del art. 2008.

COLTELLI SAGOMATI			
Dimensioni BxHxS	R5 25x30x2	R5,5 25x30x2	R8 25x30x2
ID nr.	9521 001	9521 002	9521 003

9521

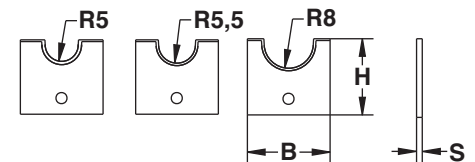

Coltelli sagomati di ricambio per art. 2009.
Shaped spare cutters for art. 2009.
 Couteaux de rechange à profil pour art. 2009.
Messern mit Profil für art. 2009.
 Cuchillas perfiladas utilizadas como repuestos del art. 2009.

COLTELLI SAGOMATI			
Dimensioni BxHxS	R10 40x35x2	R12,5 40x35x2	R15 40x35x2
ID nr.	9522 001	9522 002	9522 003

9522

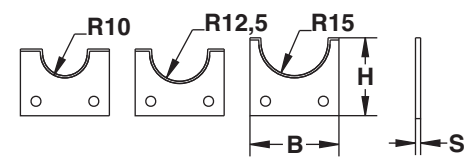

Coltelli sagomati di ricambio per art. 2010.
Shaped spare cutters for art. 2010.
 Couteaux de rechange à profil pour art. 2010.
Messern mit Profil für art. 2010.
 Cuchillas perfiladas utilizadas como repuestos del art. 2010.

COLTELLI SAGOMATI	
Dimensioni BxHxS	40x35x2
ID nr.	9523 001

9523

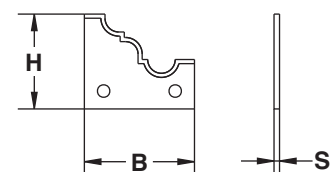

9524

Coltelli sagomati di ricambio per art. 2011.
Shaped spare cutters for art. 2011.
 Couteaux de rechange à profil pour art. 2011.
Messern mit Profil für art. 2011.
 Cuchillas perfiladas utilizadas como repuestos del art. 2011.

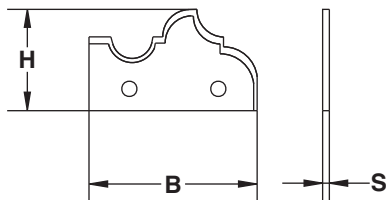

COLTELLI SAGOMATI	
Dimensioni BxHxS	50x30x2
ID nr.	9524 001

9525

Coltelli sagomati di ricambio per art. 2012.
Shaped spare cutters for art. 2012.
 Couteaux de rechange à profil pour art. 2012.
Messern mit Profil für art. 2012.
 Cuchillas perfiladas utilizadas como repuestos del art. 2012.

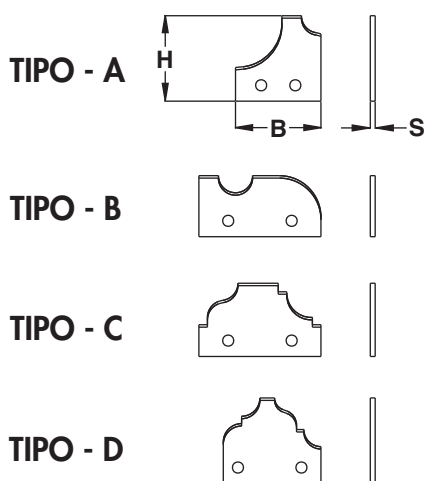

COLTELLI SAGOMATI		
TIPO	A	B
Dimensioni BxHxS	35x35x2	50x30x2
ID nr.	9525 001	9525 002
TIPO	C	D
Dimensioni BxHxS	50x35x2	40x35x2
ID nr.	9525 003	9525 004

9526

Coltelli sagomati di ricambio per art. 2015.
Shaped spare cutters for art. 2015.
 Couteaux de rechange à profil pour art. 2015.
Messern mit Profil für art. 2015.
 Cuchillas perfiladas utilizadas como repuestos del art. 2015.

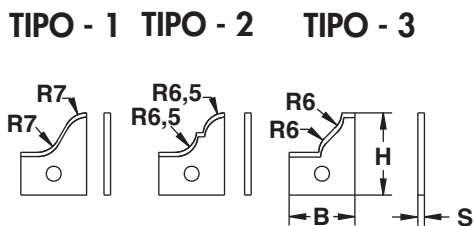

COLTELLI SAGOMATI			
TIPO	A	2	3
Dimensioni BxHxS	35x35x2	20x25x2	20x25x2
ID nr.	9525 001	9526 002	9526 003

Coltelli sagomati di ricambio per art. 2028.
Shaped spare cutters for art. 2028.
 Couteaux de rechange à profil pour art. 2028.
Messern mit Profil für art. 2028.
 Cuchillas perfiladas utilizadas como repuestos del art. 2028.

9527

COLTELLI SAGOMATI				
Altezza	n°incastrati=1		n°incastrati=2	
	H=8	H=12	H=8	H=12
Dimensioni BxHxS	30x25x2	30x30x2	50x25x2	50x30x2
ID nr.	9527 001	9527 002	9527 007	9527 008

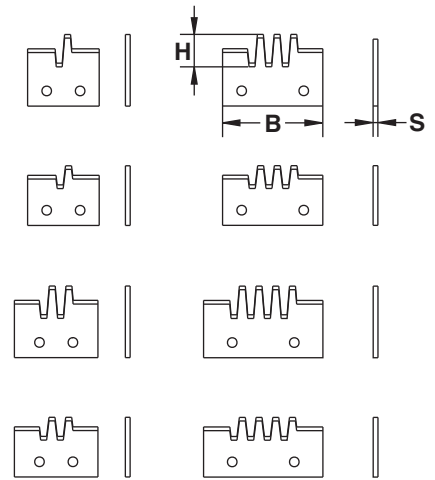

COLTELLI SAGOMATI				
Altezza	n°incastrati=3		n°incastrati=4	
	H=8	H=12	H=8	H=12
Dimensioni BxHxS	42x25x2	42x28x2	50x25x2	50x30x2
ID nr.	9527 005	9527 006	9527 007	9527 008

Coltelli sagomati di ricambio per art. 2029.
Shaped spare cutters for art. 2029.
 Couteaux de rechange à profil pour art. 2029.
Messern mit Profil für art. 2029.
 Cuchillas perfiladas utilizadas como repuestos del art. 2029.

9528

COLTELLI SAGOMATI				
TIPO	A1	A2	B1	B2
Dimensioni BxHxS	40x25x2	40x25x2	40x25x2	40x25x2
ID nr.	9528 011	9528 012	9528 013	9528 014
TIPO	C1	C2	D1	D2
Dimensioni BxHxS	40x25x2	40x25x2	40x30x2	40x30x2
ID nr.	9528 015	9528 016	9528 021	9528 022
TIPO	E1	E2	F1	F2
Dimensioni BxHxS	40x30x2	40x30x2	40x30x2	40x30x2
ID nr.	9528 023	9528 024	9528 025	9528 026

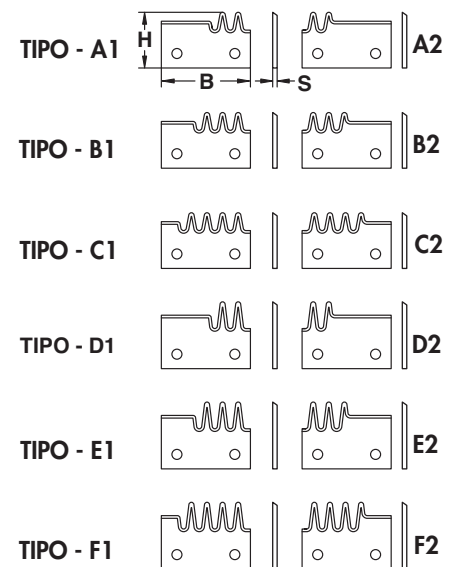

9532

DX SX

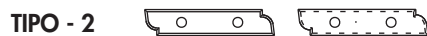

9533

DX SX

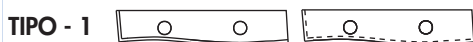

9534

DX SX

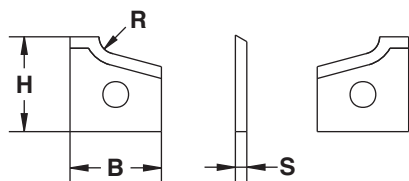

Coltelli sagomati di ricambio per art. 2040.
Shaped spare cutters for art. 2040.
 Couteaux de rechange à profil pour art. 2040.
Messern mit Profil für art. 2040.
 Cuchillas perfiladas utilizadas como repuestos del art. 2040.

COLTELLI SAGOMATI

TIPO	1	2	3	4	5
BxHxS	60x12x1,5	60x12x1,5	60x12x1,5	20x12x1,5	20x12x1,5
ID nr. DX	9532 001	9532 003	9532 005	9532 021	9532 023
ID nr. SX	9532 002	9532 004	9532 006	9532 022	9532 024

Coltelli sagomati di ricambio per art. 2041.
Shaped spare cutters for art. 2041.
 Couteaux de rechange à profil pour art. 2041.
Messern mit Profil für art. 2041.
 Cuchillas perfiladas utilizadas como repuestos del art. 2041.

COLTELLI SAGOMATI

TIPO	1	4	5
Dimensioni BxHxS	60x12x1,5	20x12x1,5	20x12x1,5
ID nr. DX	9533 001	9532 021	9532 023
ID nr. SX	9533 002	9532 022	9532 024

N.B.: I coltelli tipo 4/5 sono gli stessi utilizzati nell'art. 2040.
 ATTENTION: Knives type 4/5 are the same used on art. 2040.

Coltelli sagomati di ricambio per art. 2045.
Shaped spare cutters for art. 2045.
 Couteaux de rechange à profil pour art. 2045.
Messern mit Profil für art. 2045.
 Cuchillas perfiladas utilizadas como repuestos del art. 2045.

Dimensioni BxHxS ID nr. DX ID nr. SX

COLTELLI R2 (MiniMax)	16x17x2	9534 001	9534 002
COLTELLI R2 (SM.Mec)	16x17x2	9534 005	9534 006
COLTELLI R3 (MiniMax)/(SM.Mec)	16x17x2	9534 003	9534 004
COLTELLI R2-2° (SM.Mec)	16x17x2	9534 007	9534 008
COLTELLI R2 -1,5° (SM.Mec)	16x17x2	9534 009	9534 010

Coltelli sagomati di ricambio per art. 2046.
Shaped spare cutters for art. 2046.
 Couteaux de rechange à profil pour art. 2046.
Messern mit Profil für art. 2046.
 Cuchillas perfiladas utilizadas como repuestos del art. 2046.

9535

COLTELLI SAGOMATI		
	RAGGIO-2	RAGGIO-3
Dimensioni BxHxS	20x12x1,5	20x12x1,5
ID nr. DX	9535 001	9535 003
ID nr. SX	9535 002	9535 004

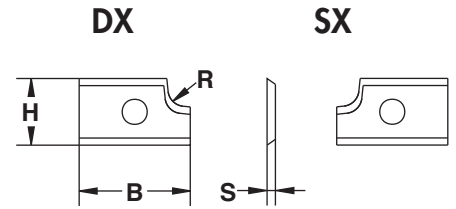

Coltelli sagomati di ricambio per art. 2047 - 3041.
Shaped spare cutters for art. 2047 - 3041.
 Couteaux de rechange à profil pour art. 2047 - 3041.
Messern mit Profil für art. 2047 - 3041.
 Cuchillas perfiladas utilizadas como repuestos del art. 2047 - 3041.

9536

TIPO - A	PER ART. 2047009/010/011/012	COLTELLI
Dimensioni BxHxS		16x14x2
ID nr.		9536 001
TIPO - B	PER ART. 2047005/006/007/008/017/018/019/020	COLTELLI
Dimensioni BxHxS		16x17,5x2
ID nr.		9536 002
TIPO - C	PER ART. 2047001/002/003/004/0210	COLTELLI
Dimensioni BxHxS		16x13,4x2
ID nr.		9536 003
TIPO - D	PER ART. 2047013/014/015/016	COLTELLI
Dimensioni BxHxS		16x14,4x2
ID nr.		9536 004
TIPO - E	PER ART. 2047101	COLTELLI
Dimensioni BxHxS		16x13,15x2
ID nr.		9536 101
TIPO - F	PER ART. 2047022/023	COLTELLI
Dimensioni BxHxS		16x14,4x2
ID nr.		9536 005

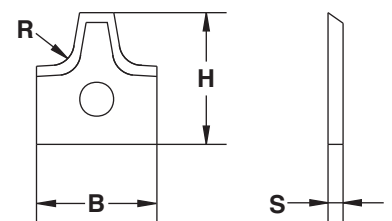

N.B.: NELL'ORDINE INDICARE CODICE E RAGGIO.
 ATTENTION: PLEASE SPECIFY BSP CODE AND RADIUS IN YOUR ORDER.

9538

Coltelli sagomati di ricambio per art. 3040 - 2032.

Shaped spare cutters for art. 3040 - 2032.

Couteaux de rechange à profil pour art. 3040 - 2032.

Messern mit Profil für art. 3040 - 2032.

Cuchillas perfiladas utilizadas como repuestos del art. 3040 - 2032.

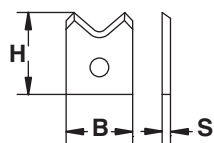
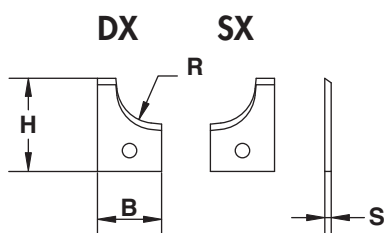
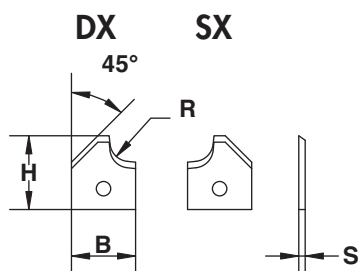

PER ART. 3040		COLTELLI SAGOMATI		
Raggio		2-45°	3-45°	4-45°
Dimensioni BxHxS		20x25x2	20x25x2	20x25x2
ID nr. DX		9538 001-01	9538 001-02	9538 001-03
ID nr. SX		9538 002-01	9538 002-02	9538 002-03
Raggio		5-45°	6-45°	
Dimensioni BxHxS		20x25x2	20x25x2	
ID nr. DX		9538 001-04	9538 001-05	
ID nr. SX		9538 002-04	9538 002-05	

PER ART. 3040		COLTELLI SAGOMATI			
Raggio		6	7	8	9
BxHxS		20x30x2	20x30x2	20x30x2	20x30x2
ID nr. DX		9538 003-01	9538 003-02	9538 003-03	9538 003-04
ID nr. SX		9538 004-01	9538 004-02	9538 004-03	9538 004-04
Raggio		10	11	12	
BxHxS		20x30x2	20x30x2	20x30x2	
ID nr. DX		9538 003-05	9538 003-06	9538 003-07	
ID nr. SX		9538 004-05	9538 004-06	9538 004-07	

PER ART. 2032		COLTELLI SAGOMATI		
Raggio		2	3	4
Dimensioni BxHxS		16x20x2	16x20x2	16x20x2
ID nr. DX		9538 011	9538 012	9538 013
ID nr. SX		-	-	-
Raggio		5	6	
Dimensioni BxHxS		16x20x2	16x20x2	
ID nr. DX		9538 014	9538 015	
ID nr. SX		-	-	

Coltelli sagomati di ricambio per art. 3050.

Shaped spare cutters for art. 3050.

Couteaux de rechange à profil pour art. 3050.

Messern mit Profil für art. 3050.

Cuchillas perfiladas utilizadas como repuestos del art. 3050.

COLTELLI SAGOMATI				
TIPO	A	B	C	D
Dimensioni BxHxS	30x25x2	30x25x2	15x25x2	30x25x2
ID nr.	9539 001	9539 002	9539 003	9539 004

9539

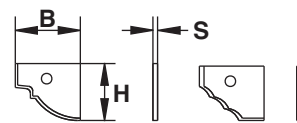

TIPO - A

TIPO - B



TIPO - C

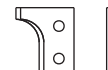

TIPO - D

Coltelli sagomati di ricambio per art. 3051.

Shaped spare cutters for art. 3051.

Couteaux de rechange à profil pour art. 3051.

Messern mit Profil für art. 3051.

Cuchillas perfiladas utilizadas como repuestos del art. 3051.

COLTELLI SAGOMATI				
TIPO	A	B	C	D
Dimensioni BxHxS	25x20x2	40x35x2	22,4x12x1,5*	23,8x12x1,5*
ID nr.	9540 001	9540 002	9540 003	9540 004

9540

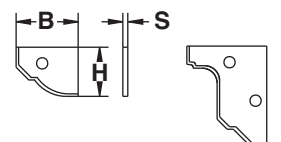

TIPO - A

TIPO - B



TIPO - C



TIPO - D

*Ricavati dal 30x12x1,5 / Realised using knife 30x12x1,5

9542

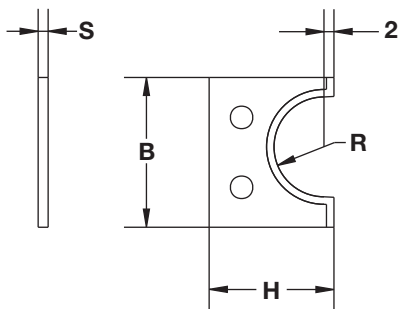

Coltelli sagomati di ricambio per art. 3055.

Shaped spare cutters for art. 3055.

Couteaux de rechange à profil pour art. 3055.

Messern mit Profil für art. 3055.

Cuchillas perfiladas utilizadas como repuestos del art. 3055.

COLTELLI SAGOMATI

	R6	R8	R9	R10
Dimensioni BxHxS	25x25x2	25x25x2	25x25x2	35x30x2
ID nr.	9542 011	9542 012	9542 013	9542 014

COLTELLI SAGOMATI

	R12	R12,5	R15	R17,5
Dimensioni BxHxS	35x30x2	35x30x2	50x35x2	50x35x2
ID nr.	9542 015	9542 016	9542 017	9542 018

COLTELLI SAGOMATI

	R20	R22,5	R25
Dimensioni BxHxS	50x35x2	60x40x2	60x40x2
ID nr.	9542 019	9542 020	9542 021

9543

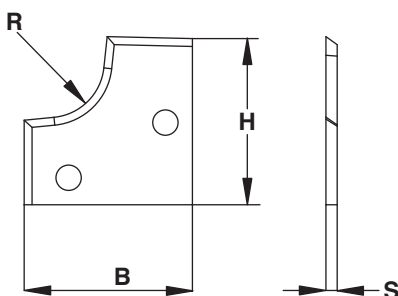

Coltelli sagomati di ricambio per art. 3056.

Shaped spare cutters for art. 3056.

Couteaux de rechange à profil pour art. 3056.

Messern mit Profil für art. 3056.

Cuchillas perfiladas utilizadas como repuestos del art. 3056.

COLTELLI SAGOMATI

	R6	R8	R9	R10
Dimensioni BxHxS	25x25x2	25x25x2	25x25x2	30x30x2
ID nr.	9543 011	9543 012	9543 013	9543 014

COLTELLI SAGOMATI

	R12	R12,5	R15	R17,5
Dimensioni BxHxS	35x30x2	35x30x2	50x35x2	50x35x2
ID nr.	9542 015	9542 016	9542 017	9542 018

COLTELLI SAGOMATI

	R20	R22,5	R25
Dimensioni BxHxS	35x35x2	40x40x2	40x40x2
ID nr.	9543 019	9543 020	9543 021

Coltelli sagomati di ricambio per art. 3061.

Shaped spare cutters for art. 3061.

Couteaux de rechange à profil pour art. 3061.

Messern mit Profil für art. 3061.

Cuchillas perfiladas utilizadas como repuestos del art. 3061.

COLTELLI SAGOMATI					
TIPO	A	B	C	D	E
BxHxS	30x25x2	25x25x2	15x25x2	15x25x2	30x30x2
ID nr.	9549 001	9549 002	9549 003	9549 004	9549 005

9549

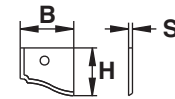

TIPO - A



TIPO - B



TIPO - C



TIPO - D



TIPO - E

Placchette di ricambio per raschiabordi art. 2048 - 2057 - 2058.

Spared tips for scraper art. 2048 - 2057 - 2058.

Plaque de rechange pour racler art. 2048 - 2057 - 2058.

Ersatz Schneidplatte für Schaber art. 2048 - 2057 - 2058.

Cuchillas de repuesto para rascadores art. 2048 - 2057 - 2058.

FIGURA-A PER ART.2048	PLACCHETTA 12,7x12,7x3,18 SAGOMATA 106°	TIPO SCM
Raggio	1	1,5
ID nr.	9550 001	9550 002
		9550 003
		9550 004

FIGURA-B PER ART.2048	PLACCHETTA 12,7x12,7x3,18 SAGOMATA 110°	TIPO BIESSE
Raggio	1	1,5
ID nr.	9550 101	9550 102
		9550 103
		9550 104

FIGURA - A



FIGURA - B



9550

Placchette di ricambio per raschiabordi art. 2048 - 2057 - 2058.

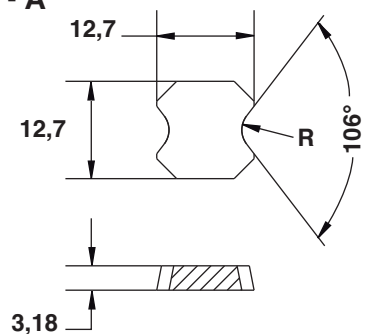
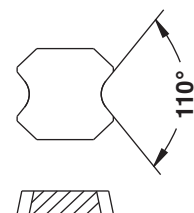
Spared tips for scraper art. 2048 - 2057 - 2058.

Plaque de rechange pour racler art. 2048 - 2057 - 2058.

Ersatz Schneidplatte für Schaber art. 2048 - 2057 - 2058.

Cuchillas de repuesto para rascadores art. 2048 - 2057 - 2058.

FIGURA - C



FIGURA-C PER ART.2057

PLACCHETTA 20x12x2 SAGOMATA

Raggio	1	1,5	2	3
ID nr.	9550 201	9550 202	9550 203	9550 204

FIGURA - D

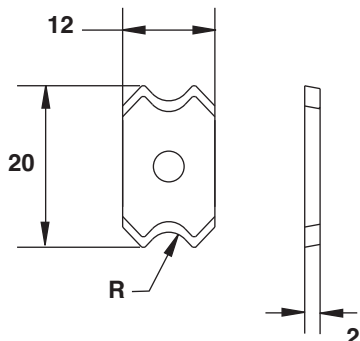

FIGURA-D PER ART.2058

PLACCHETTA 34x12,7x3 SAGOMATA

Raggio	1,0-2,0-3,0-115°	1,5-2,0-3,0-115°
ID nr.	9550 301	9550 302
Raggio	2,0-3,0-5,0-115°	1,5-2,0-2,5-115°
ID nr.	9550 303	9550 304

FIGURA - E

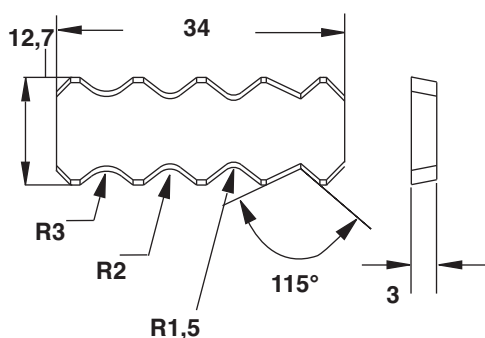

FIGURA-E

PLACCHETTA RCS 15,87x15,87x4,76

Raggio	1	1,5	2	3
ID nr.	9550 401	9550 402	9550 403	9550 404

FIGURA - F

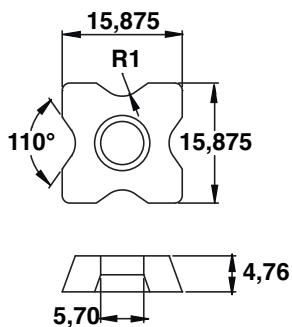

FIGURA-F

RASANTI IN HM TRIANGOLARI 22,86 SP = 2,5

ID nr.	9550 501
--------	-----------------

Coltelli sagomati di ricambio per art. 2052.
Shaped spare cutters for art. 2052.
 Couteaux de rechange à profil pour art. 2052.
Messern mit Profil für art. 2052.
 Cuchillas perfiladas utilizadas como repuestos del art. 2052.

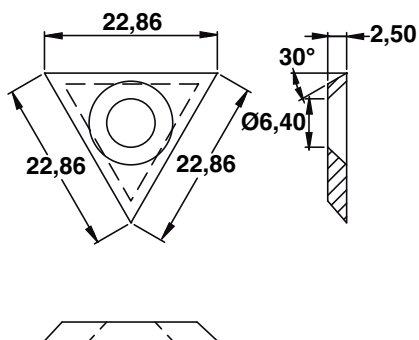
FIGURA-B PER ART.2048 PLACCHETTA 12,7x12,7x3,18 SAGOMATA 110°

RAGGIO	1,5	2,0	3,0	4,0	5,0
BxHxS	12x20x2	12x20x2	12x20x2	12x20x2	15x20x2
ID nr.	9551 003	9551 004	9551 006	9551 008	9551 010

COLTELLI SAGOMATI

β	30°	45°	60°
BxHxS	12x20x2	12x20x2	12x20x2
ID nr.	9551 021	9551 022	9551 023

9551

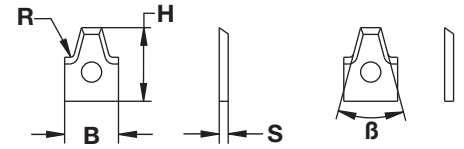

Coltelli sagomati di ricambio per art. 2051.
Shaped spare cutters for art. 2051.
 Couteaux de rechange à profil pour art. 2051.
Messern mit Profil für art. 2051.
 Cuchillas perfiladas utilizadas como repuestos del art. 2051.

COLTELLI SAGOMATI

RAGGIO	1,0	1,5	2,0	2,5	3,0
BxHxS	15x12x1,5	15x12x1,5	15x12x1,5	15x12x1,5	15x12x1,5
ID nr.	9553 001	9553 003	9553 005	9553 007	9553 009
ID nr. SX	9553 002	9553 004	9553 006	9553 008	9553 010

9553

DX



SX

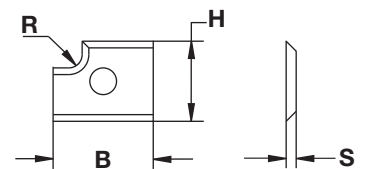

9554

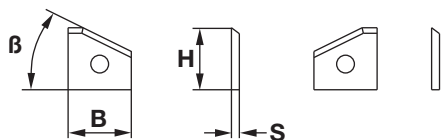
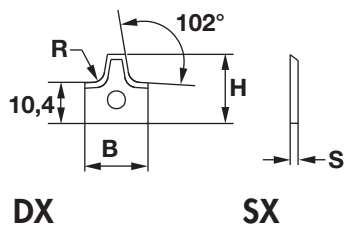

Coltelli sagomati di ricambio per art. 2054.

Shaped spare cutters for art. 2054.

Couteaux de rechange à profil pour art. 2054.

Messern mit Profil für art. 2054.

Cuchillas perfiladas utilizadas como repuestos del art. 2054.

COLTELLI SAGOMATI

RAGGIO	1,5	2,0	3,0	4,0	5,0
BxHxS	16x17,5x2	16x17,5x2	16x17,5x2	16x17,5x2	16x17,5x2
ID nr.	9554 001	9554 002	9554 003	9554 004	9554 005

COLTELLI SAGOMATI

β	25°
BxHxS	16x15,7x2
ID nr. DX	9554 011
ID nr. SX	9554 012

9555

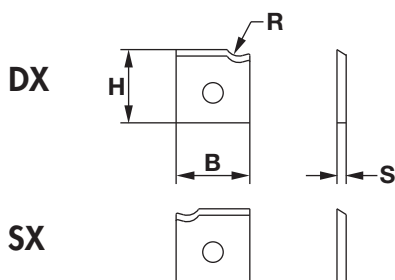

Coltelli sagomati di ricambio per art. 2055.

Shaped spare cutters for art. 2055.

Couteaux de rechange à profil pour art. 2055.

Messern mit Profil für art. 2055.

Cuchillas perfiladas utilizadas como repuestos del art. 2055.

COLTELLI SAGOMATI

RAGGIO	1,5	2,0	3,0
Dimensioni BxHxS	16x15,9x2	16x15,9x2	16x15,9x2
ID nr. DX	9555 001	9555 003	9555 005
ID nr. SX	9555 002	9555 004	9555 006

9556

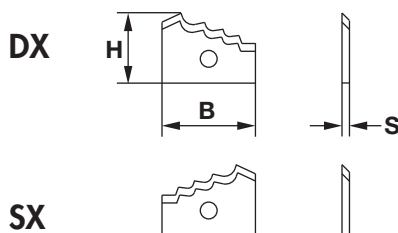

Coltelli sagomati di ricambio per art. 2056.

Shaped spare cutters for art. 2056.

Couteaux de rechange à profil pour art. 2056.

Messern mit Profil für art. 2056.

Cuchillas perfiladas utilizadas como repuestos del art. 2056.

COLTELLI SAGOMATI

RAGGIO	DIRITTO 1,5 - 2,0 - 3,0
Dimensioni BxHxS	25x18,7x2
ID nr. DX	9556 001
ID nr. SX	9556 002

Coltelli sagomati di ricambio per art. 2060.

Shaped spare cutters for art. 2060.

Couteaux de rechange à profil pour art. 2060.

Messern mit Profil für art. 2060.

Cuchillas perfiladas utilizadas como repuestos del art. 2060.

COLTELLI SAGOMATI				
TIPO	A	B	C	D
Dimensioni BxHxS	25x30x2	25x30x2	25x30x2	25x30x2
ID nr.	9557 001	9557 002	9557 003	9557 004

9557

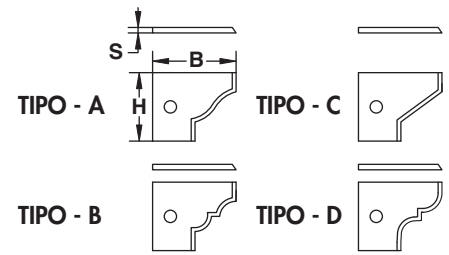

Coltelli sagomati di ricambio per art. 2065.

Shaped spare cutters for art. 2065.

Couteaux de rechange à profil pour art. 2065.

Messern mit Profil für art. 2065.

Cuchillas perfiladas utilizadas como repuestos del art. 2065.

COLTELLI SAGOMATI			
RAGGIO	A	B	C
Dimensioni BxHxS	50x18x2	50x19x2	50x19x2
ID nr.	9558 001	9558 002	9558 003

9558

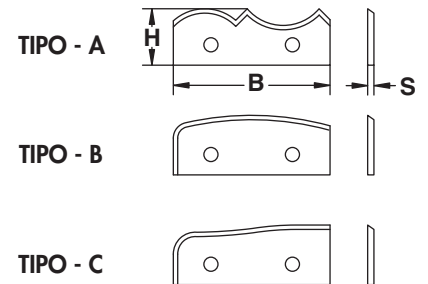

Coltelli sagomati di ricambio per art. 2066 - 2067.

Shaped spare cutters for art. 2066 - 2067.

Couteaux de rechange à profil pour art. 2066 - 2067.

Messern mit Profil für art. 2066 - 2067.

Cuchillas perfiladas utilizadas como repuestos del art. 2066 - 2067.

COLTELLI SAGOMATI				
TIPO	A	B	C	D
Dimensioni BxHxS	30x30x2	30x30x2	30x30x2	30x30x2
ID nr. DX	9559 001	9559 003	9559 005	9559 007
ID nr. SX	9559 002	9559 004	9559 006	9559 008
TIPO	A1	B1	C1	D1
Dimensioni BxHxS	25x30x2	25x30x2	25x30x2	25x30x2
ID nr. DX	9559 009	9559 011	9559 013	9559 015
ID nr. SX	9559 010	9559 012	9559 014	9559 016

9559

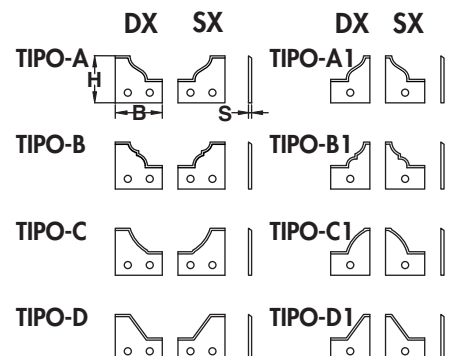

9560

Coltelli sagomati di ricambio per art. 2069.

Shaped spare cutters for art. 2069.

Couteaux de rechange à profil pour art. 2069.

Messern mit Profil für art. 2069.

Cuchillas perfiladas utilizadas como repuestos del art. 2069.

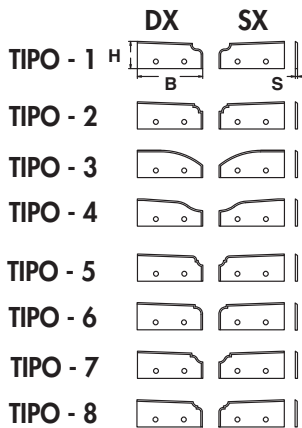

COLTELLI SAGOMATI

TIPO	1	2	3	4
Dimensioni BxHxS	60x25x2	60x25x2	60x25x2	60x25x2
ID nr. DX	9560 001	9560 003	9560 005	9560 007
ID nr. SX	9560 002	9560 004	9560 006	9560 008
TIPO	5	6	7	8
Dimensioni BxHxS	60x25x2	60x25x2	60x25x2	60x25x2
ID nr. DX	9560 009	9560 011	9560 013	9560 015
ID nr. SX	9560 010	9560 012	9560 014	9560 016

9562

Coltelli sagomati di ricambio per art. 2071.

Shaped spare cutters for art. 2071.

Couteaux de rechange à profil pour art. 2071.

Messern mit Profil für art. 2071.

Cuchillas perfiladas utilizadas como repuestos del art. 2071.

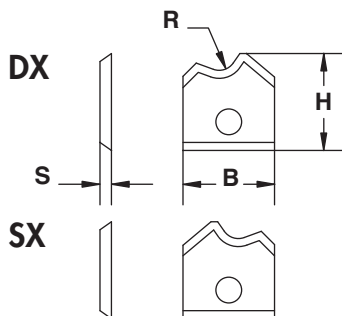

COLTELLI SAGOMATI

RAGGIO	1	2	3
Dimensioni BxHxS	16x17x2	16x17x2	16x17x2
ID nr. DX	9562 001	9562 003	9562 005
ID nr. SX	9562 002	9562 004	9562 006

Coltelli sagomati di ricambio per art. 2072.

Shaped spare cutters for art. 2072.

Couteaux de rechange à profil pour art. 2072.

Messern mit Profil für art. 2072.

Cuchillas perfiladas utilizadas como repuestos del art. 2072.

COLTELLI SAGOMATI		
RAGGIO	2	3
Dimensioni BxHxS	16x17,5x2	16x17,5x2
ID nr. DX	9563 001	9563 003
ID nr. SX	9563 002	9563 004

9563

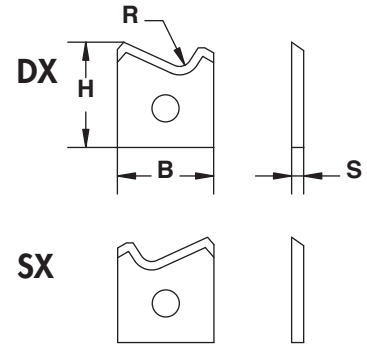

Coltelli sagomati di ricambio per art. 3049.

Shaped spare cutters for art. 3049.

Couteaux de rechange à profil pour art. 3049.

Messern mit Profil für art. 3049.

Cuchillas perfiladas utilizadas como repuestos del art. 3049.

PER ART. 3049001	COLTELLI SAGOMATI			
TIPO - C	1	2	3	4
Dimensioni BxHxS	16x30x2	16x30x2	16x30x2	16x30x2
ID nr.	9564 001	9564 002	9564 003	9564 004

PER ART. 3049003	COLTELLI SAGOMATI			
TIPO - A	1	2	3	4
Dimensioni BxHxS	20x25x2	20x25x2	20x25x2	20x25x2
ID nr.	9564 011	9564 012	9564 013	9564 014
TIPO - B	1			
Dimensioni BxHxS	20x25x2			
ID nr.	9564 021			

9564

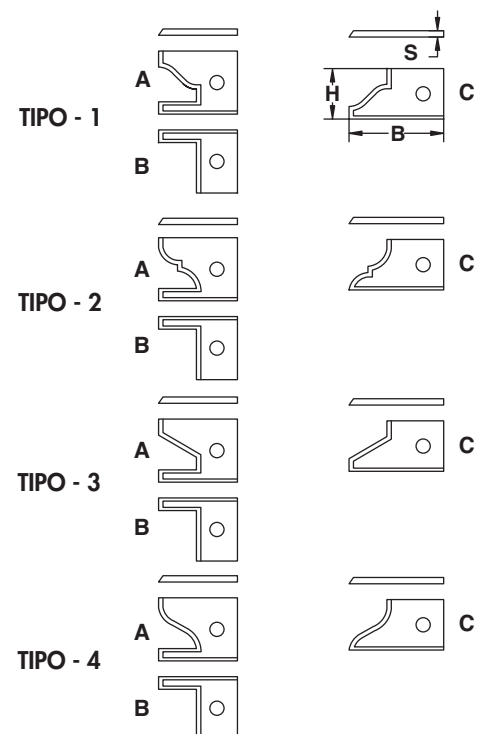

9566

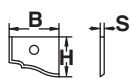

TIPO - A



TIPO - B



TIPO - C



TIPO - D



TIPO - E

Coltelli sagomati di ricambio per art. 3069.

Shaped spare cutters for art. 3069.

Couteaux de rechange à profil pour art. 3069.

Messern mit Profil für art. 3069.

Cuchillas perfiladas utilizadas como repuestos del art. 3069.

COLTELLI SAGOMATI

TIPO	A	B	C	D	E
BxHxS	25x20x2	20x20x2	15x25x2	15x25x2	30x30x2
ID nr.	9566 001	9566 002	9566 003	9566 004	9566 005

9567

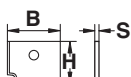

TIPO - A



TIPO - B



TIPO - C



TIPO - D

Coltelli sagomati di ricambio per art. 3070.

Shaped spare cutters for art. 3070.

Couteaux de rechange à profil pour art. 3070.

Messern mit Profil für art. 3070.

Cuchillas perfiladas utilizadas como repuestos del art. 3070.

COLTELLI SAGOMATI

TIPO	A	B	C	D
Dimensioni BxHxS	25x20x2	25x20x2	15x25x2	30x30x2
ID nr.	9567 001	9567 002	9567 003	9567 004

9568

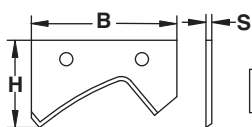

TIPO - A



TIPO - B

Coltelli sagomati di ricambio per art. 3071.

Shaped spare cutters for art. 3071.

Couteaux de rechange à profil pour art. 3071.

Messern mit Profil für art. 3071.

Cuchillas perfiladas utilizadas como repuestos del art. 3071.

COLTELLI SAGOMATI

TIPO	A	B
Dimensioni BxHxS	50x30x2	30x20x2
ID nr.	9568 001	9568 002

Coltelli sagomati di ricambio per art. 3062.

Shaped spare cutters for art. 3062.

Couteaux de rechange à profil pour art. 3062.

Messern mit Profil für art. 3062.

Cuchillas perfiladas utilizadas como repuestos del art. 3062.

PER ART. 3062001/002/003/004				
COLTELLI SAGOMATI				
TIPO	1	2	3	4
Dimensioni	25x30x2	25x30x2	25x30x2	25x30x2
ID nr. DX	9569 001	9569 003	9569 005	9569 007
ID nr. SX	9569 002	9569 004	9569 006	9569 008
TIPO	5	6	7	8
Dimensioni	25x30x2	25x30x2	25x30x2	25x30x2
ID nr. DX	9569 009	9569 011	9569 013	9569 015
ID nr. SX	9569 010	9569 012	9569 014	9569 016

PER ART. 3062007		
COLTELLI SAGOMATI		
TIPO	9	10
Dimensioni	50x25x2	50x25x2
ID nr. DX	9569 017	9569 019
ID nr. SX	9569 018	9569 020

PER ART. 3062006				
COLTELLI SAGOMATI				
TIPO	11	12	13	14
Dimensioni	12x19,85x2	12x19,85x2	12x19,85x2	12x19,85x2
ID nr. DX	9569 021	9569 022	9569 023	9569 024
ID nr. SX	-	-	-	-

Coltelli sagomati di ricambio per art. 3063.

Shaped spare cutters for art. 3063.

Couteaux de rechange à profil pour art. 3063.

Messern mit Profil für art. 3063.

Cuchillas perfiladas utilizadas como repuestos del art. 3063.

COLTELLI SAGOMATI				
TIPO	1	2	3	4
Dimensioni	25x25x2	25x25x2	25x25x2	25x25x2
ID nr. DX	9570 001	9570 002	9570 003	9570 004
TIPO	5	6	7	8
Dimensioni BxHxS	25x25x2	25x25x2	25x25x2	25x25x2
ID nr. DX	9570 011	9570 012	9570 013	9570 014
TIPO	9	10	11	12
Dimensioni BxHxS	25x25x2	25x25x2	25x25x2	25x25x2
ID nr. DX	9570 021	9570 022	9570 023	9570 024

9569

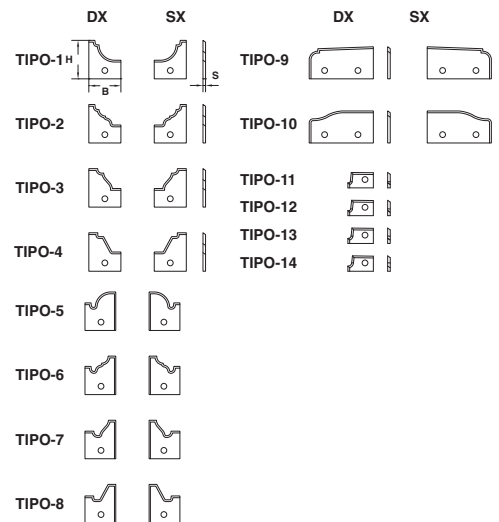

9570

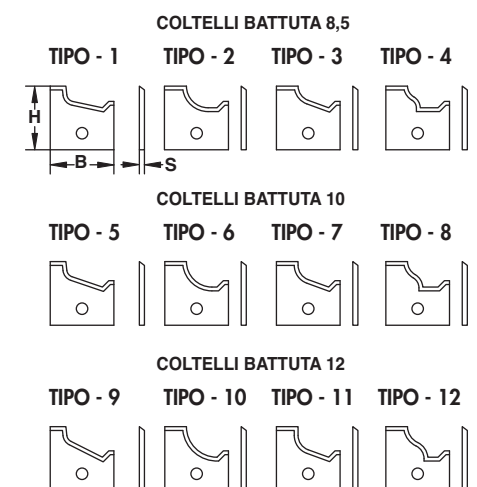

9571

Coltelli sagomati di ricambio per art. 2076.
Shaped spare cutters for art. 2076.
 Couteaux de rechange à profil pour art. 2076.
Messern mit Profil für art. 2076.
 Cuchillas perfiladas utilizadas como repuestos del art. 2076.

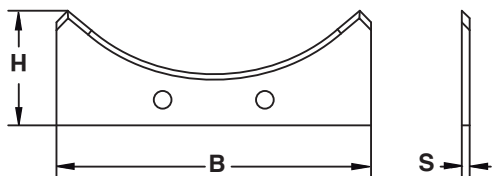

COLTELLI SAGOMATI			
	R30	R35	R40
Dimensioni BxHxS	60x30x2	60x30x2	60x30x2
ID nr. DX	9571 001	9571 002	9571 003
ID nr. SX	-	-	-

COLTELLI SAGOMATI			
	R45	R50	R55
Dimensioni BxHxS	80x30x2	80x30x2	80x30x2
ID nr. DX	9571 011	9571 012	9571 013
ID nr. SX	-	-	-

9572

Coltelli sagomati di ricambio per art. 2077.
Shaped spare cutters for art. 2077.
 Couteaux de rechange à profil pour art. 2077.
Messern mit Profil für art. 2077.
 Cuchillas perfiladas utilizadas como repuestos del art. 2077.

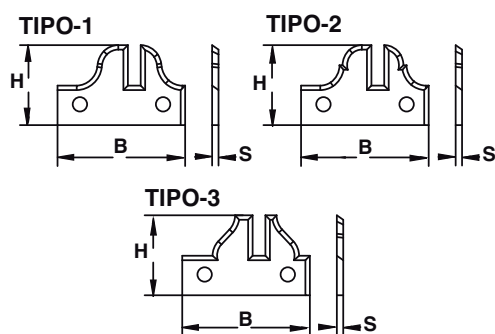

COLTELLI SAGOMATI			
	1	2	3
Dimensioni BxHxS	40x25x2	40x25x2	40x25x2
ID nr. DX	9572 001	9572 002	9572 003

9573

Coltelli sagomati di ricambio per art. 2038.
Shaped spare cutters for art. 2038.
 Couteaux de rechange à profil pour art. 2038.
Messern mit Profil für art. 2038.
 Cuchillas perfiladas utilizadas como repuestos del art. 2038.

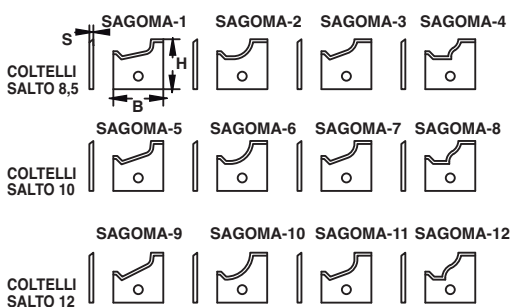

BATTUTA 8,5 COLTELLI SAGOMATI				
TIPO	1	2	3	4
Dimensioni BxHxS	25x25x2	25x25x2	25x25x2	25x25x2
ID nr.	9573 001	9573 002	9573 003	9573 004

BATTUTA 10 COLTELLI SAGOMATI				
TIPO	5	6	7	8
Dimensioni BxHxS	25x25x2	25x25x2	25x25x2	25x25x2
ID nr.	9573 011	9573 012	9573 013	9573 014

BATTUTA 12 COLTELLI SAGOMATI				
TIPO	9	10	11	12
Dimensioni BxHxS	25x25x2	25x25x2	25x25x2	25x25x2
ID nr.	9573 021	9573 022	9573 023	9573 024

Coltelli sagomati di ricambio per art. 2080.
Shaped spare cutters for art. 2080.
 Couteaux de rechange à profil pour art. 2080.
Messern mit Profil für art. 2080.
 Cuchillas perfiladas utilizadas como repuestos del art. 2080.

COLTELLI SAGOMATI	
Dimensioni BxHxS	16x30x2
ID nr. DX	9574 001
ID nr. SX	9574 002

9574

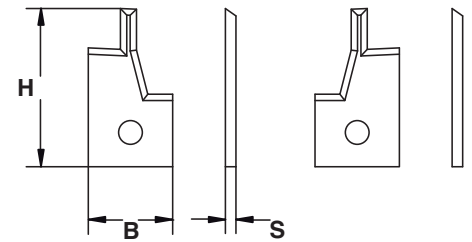

Coltelli sagomati di ricambio per art. 2081.
Shaped spare cutters for art. 2081.
 Couteaux de rechange à profil pour art. 2081.
Messern mit Profil für art. 2081.
 Cuchillas perfiladas utilizadas como repuestos del art. 2081.

COLTELLI SAGOMATI		
RAGGIO	2	3
Dimensioni BxHxS	20x12x2	20x12x2
ID nr. DX	9575 001	9575 003
ID nr. SX	9575 002	9575 004

9575

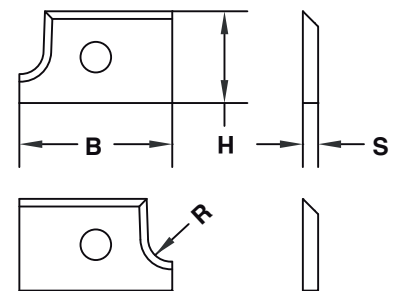

Coltelli sagomati di ricambio per art. 3073.
Shaped spare cutters for art. 3073.
 Couteaux de rechange à profil pour art. 3073.
Messern mit Profil für art. 3073.
 Cuchillas perfiladas utilizadas como repuestos del art. 3073.

COLTELLI SAGOMATI		
TIPO	1	2
Dimensioni BxHxS	16x7x1,5	16x7x1,5
ID nr.	9576 001	9576 002

9576

TIPO-1

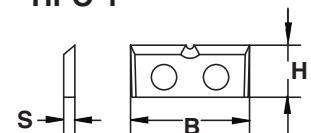

TIPO-2

